



ABBHEY

Installing Excellence In The Thames Valley For 30 Years



WINDOWS,
DOORS AND
CONSERVATORIES





Abbey Windows

Installing Excellence in The Thames Valley For Over 30 Years

With decades of valuable experience, Abbey Windows know and understand local buildings and materials making them an excellent choice when seeking to improve your home or building. Their standing and reputation within the industry even extends to appearances with professional advice on TV programmes on C4 and Channel 5 as well as local radio.

Abbey Windows boast a wide portfolio of completed projects. Their exceptional services and fantastic value for money has seen them complete thousands of double glazing installations across Reading, Henley On Thames, Wokingham and the Thames Valley.

With a quality in-house team of professional installers, Abbey Windows offer a complete double glazing service. From windows and doors, to conservatories and orangeries, their products compliment homes, business and commercial properties alike.

Promoting British Made Products

As a locally run independent double glazing company, Abbey Windows promise great quality, choice and price. They actively promote British manufactured products including, Liniar PVC, Origin Bi Folds, Composite Doors and an innovative selection of glasses. Abbey Windows offer ranges of uPVC and aluminium products to compliment every type of modern or period property.



Official Police Security Initiative

Secured By Design

Putting home security first, Liniar & other products are available with Police Approved Secured By Design accreditation offering amongst the most secure double glazing available.

*Secured by Design offered as an upgrade from standard product



Liniar

Liniar's industry leading range of uPVC windows and doors are environmentally friendly, 100 % lead free and offer exceptional levels of energy efficiency.



Call Us On: 0118 956 6866 Email: info@abbeywindows.co.uk

Website: www.abbeywindows.co.uk





CONTENTS

| | | | |
|----------------------------|-----------|-------------------------------|-----------|
| Liniar | 6 | Doors | 44 |
| Welcome to Liniar | 6 | Entrance Doors | 44 |
| The Perfect Profile | 7 | Composite Doors | 46 |
| Guarantee | 8 | Back Doors | 48 |
| <hr/> | | Stable Doors | 50 |
| Energy Efficiency | 10 | French Doors | 52 |
| Better for the Environment | 11 | Patio Doors | 54 |
| Energy Ratings | 12 | Bi-fold Doors | 56 |
| <hr/> | | Door Accessories | 58 |
| Windows | 14 | Door Letterboxes | 59 |
| Hand Finishing | 14 | Yale Lockmaster™ | 60 |
| Casement Windows | 16 | <hr/> | |
| Security is our Priority | 18 | Colours & Profiles | 62 |
| Hinge Options | 20 | Colour Options | 62 |
| Window Accessories | 21 | Profile Options | 63 |
| Colour Options | 22 | <hr/> | |
| Bow and Bay Windows | 24 | Conservatories | 64 |
| Tilt and Turn Windows | 26 | Design Options | 66 |
| Vertical Sliders | 28 | Roof Options | 68 |
| Sash Horn Windows | 30 | Conservatory Process | 70 |
| French Casement Windows | 32 | <hr/> | |
| Flush Sash Windows | 34 | <hr/> | |
| <hr/> | | | |
| Glass | 36 | | |
| Astragal Bars | 36 | | |
| Homeguard | 38 | | |
| Obscure Glass | 40 | | |
| Leaded Glass | 42 | | |
| Decorative Glass | 43 | | |

WELCOME TO



Enhance your home with the most technically advanced uPVC window system in the UK

Innovative

Liniar's ground-breaking windows and doors have been designed from scratch. They meet the technical requirements of today whilst also anticipating future industry changes, ensuring your windows of today remain state of the art tomorrow.



Energy Efficiency

Liniar's revolutionary multi-chambered profile technology is far more thermally effective than previous generation uPVC window systems. Our windows and doors are capable of achieving the very highest standards in energy efficiency featuring double, triple and Homeguard glazing.



British Engineering

Liniar profiles are manufactured using 100% lead free. A totally lead free product substantially minimises the environmental dangers of lead and allows any waste to be safely recycled for alternative products.



Environmentally Friendly

Liniar profiles are manufactured using 100% lead free materials. The environmental dangers of lead are well known and providing a totally lead free range of products substantially minimises environmental impact.



Guarantee

Liniar products carry a 10 year Manufacturer's guarantee against cracking, warping or discolouration. And as development is continuous, you can be assured of Purchasing windows and doors designed and built to last.



THE PERFECT PROFILE



1 Flipper Gasket



Unique 'glazing flipper' reduces cold transfer, water ingress and noise pollution.

2 Multi-Chambered



Size-optimised chambers break up mini convection currents locking in pockets of warm air.

3 Superior Gaskets



High performance (patented) double action 'bubble' gaskets maintain Air and water tight weather seals.

4 Integrated Reinforcing



Internal design provides exceptional rigidity and anchor points for fixing, reducing the need for metal reinforcement.

5 Positive Drainage



Specially designed to route and expel any water and prevent moisture build-up.

6 Thermal Dam



Designed to Passivhaus standards with a thermal dam reducing heat loss.

10 Year Product

Linlar profiles are manufactured using formulations from approved suppliers and are guaranteed against fading or discolouration for 10 years from date of manufacture.

10 Year Product

Linlar profiles are manufactured using formulations from approved suppliers and are guaranteed against fading or discolouration for 10 years from date of manufacture.

This guarantee is issued in association with our raw material suppliers and based on proven technology for UV stabilised products.

Further details, weathering data and full conditions can be supplied on request.

All products to be installed to Linlar recommendations.



www.linlar.co.uk

GUARANTEE

Feel secure with a 10 year manufacturer's guarantee covering all of our products.

Liniar 10 Year Product Guarantee

Liniar PVC products are manufactured using revolutionary technology from approved suppliers and will not warp, split or discolour for 10 years.

Whilst competitors offer industry standard guarantees of as little as 12 months for hardware, our Liniar Products are offered with a full 10 Year Guarantee for handles, hinges and locks.

Guarantees for our full range of products may vary slightly but are generally also 10 Years with the option on our Bi Folds to register your own extension to a 20 Year Guarantee.

More details are available upon request.

Of course a guarantee is important. But Abbey consider so much more. All of our products are designed to last considerably longer than any guarantee and once fitted, their staff on hand will show you which parts need an occasional clean or lubrication to ensure trouble free use for many year after any guarantee has expired.



ENERGY EFFICIENCY

Save energy - Save money.

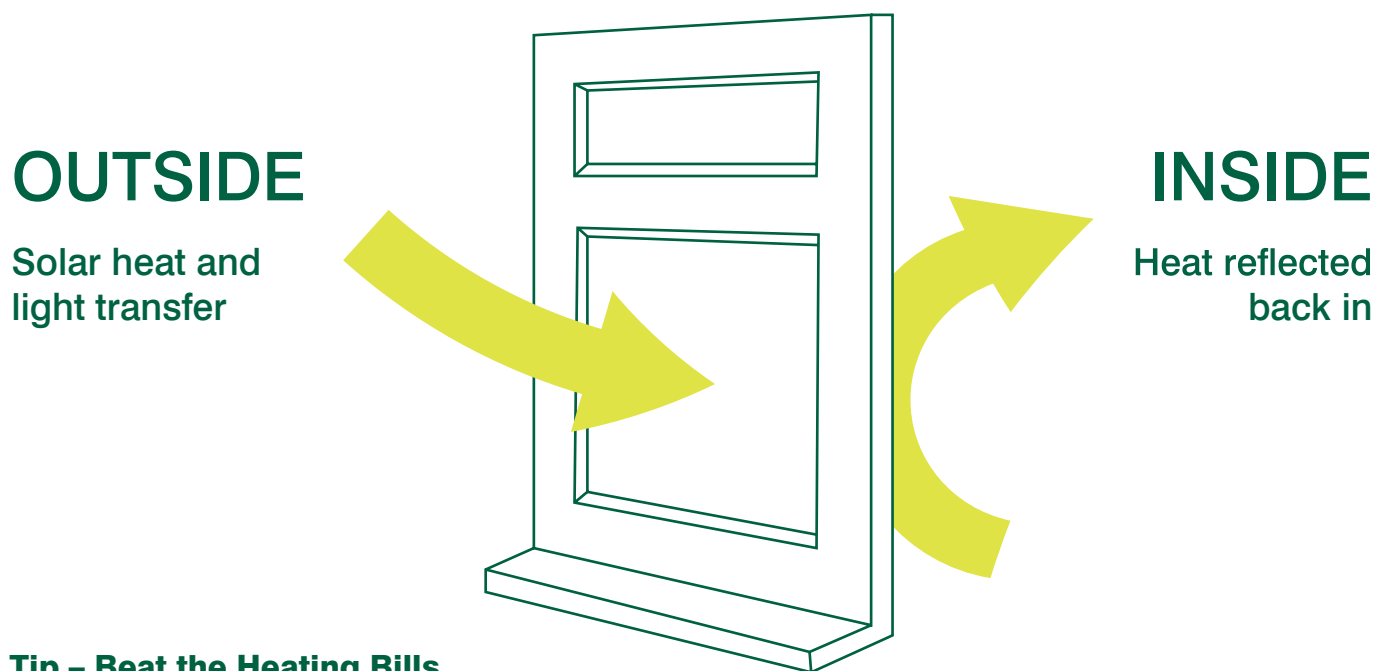

Tip – Beat the Heating Bills

Greater heat loss prevention from our windows allows you to turn heating on later and turn it off earlier in the evening.

Gain Free Solar Heat

Our energy efficient windows have a dual functionality that allows you to gain free energy (G Value) from our greatest natural resource; the sun.

The tight weather seals of the windows prevent cold wind and rain from entering your property whilst the glass allows natural free energy from the sun to enter and heat your home.

The glass of the windows has a transparent metallic coating that reflects heat back inside just like a Thermos flask, (U Value) retaining warmth and reducing the amount of energy needed to heat your home. Put simply, saving energy can save you money!

Cheaper Heating Bills

Our windows are capable of achieving an A+12 energy rating. Our standard A Rated window would retain an additional 12 kWh per m² each year over an old non Rated double glazed window

This could mean a saving on your heating bill of £156 or as much as £223 if changing from single glazed windows.

Calculations for this example are based on A rated windows on a detached property using a standard gas boiler. Obtained from

- www.ggf.org.uk
- www.energysavingtrust.org.uk

BETTER FOR OUR ENVIRONMENT

See how our windows build a greener future.



100% Lead-Free

Our windows are 100% lead free. The dangers of lead are well known and we are extremely proud to supply one of the few window systems to offer an entirely lead free range of products.



Commitment to Recycling

Our uPVC windows are extremely robust and do not need expensive steel reinforcement. They are therefore 100% recyclable making them a truly environmentally friendly product.



Reduce your Carbon Footprint

Having uPVC windows installed throughout your property will reduce the amount of energy you use and can lower your CO₂ emissions by approximately 2/3 of a tonne (680kg) each year.

Energy Window

TruFrame
PVC-U Casement Window
Linear Sculptured A+ Suite



Energy Index (kWh/m²/year)
(Energy Index certificate by BFRC and based on UK standard window specific application will depend on the building, the local climate and the indoor temperature)

12

The Climate zone is

UK

Thermal Transmittance (U window)
Solar Factor (g window)
Effective Air Leakage (L factor)

1.3 W/m².K
0.47
0.00 W/m².K

Reg. No.: 4413
Review Date: 12/2013
Please visit www.bfrc.org to check the validity of this licence.

This label is not a statutory requirement. It is a voluntary label provided as a customer service to allow consumers to make informed decisions on the energy performance of competing products.

Energy Index (kWh/m²/year)
(Energy Index certificate by BFRC and based on UK standard window specific application will depend on the building, the local climate and the indoor temperature)

1.4 W/m².K
0.44
0.00 W/m².K

The Climate zone is

Thermal Transmittance (U window)
Solar Factor (g window)
Effective Air Leakage (L factor)

Reg. No.: 4358
Review Date: 12/2013
Please visit www.bfrc.org to check the validity of this licence.



This label is not a statutory requirement. It is a voluntary label provided as a customer service to allow consumers to make informed decisions on the energy performance of competing products.



ENERGY RATINGS

Endorsed by the industry's energy specialists.

What Are Energy Ratings?

In 2004 Window Energy Ratings (WER) were introduced by the British Fenestration Ratings Council (BFRC) in order to simplify the method of comparing the energy efficiency of windows.

The energy rating of the window, described as a letter from A (best) to G (least efficient), is determined by the amount of energy the product will either lose or supply to the property over the course of a year.



BFRC

The BFRC (British Fenestration Rating Council) runs the Window Energy Ratings (WER) scheme. We are proud to say that our energy efficient uPVC windows are all BFRC approved.



WER (Window Energy Ratings)

The WER system (just like a fridge) shows the energy efficiency of a window. Our standard windows offer A but are capable of achieving an A+12 rating, the highest level of energy efficiency.



Energy Saving Trust

Our uPVC windows are endorsed to display the 'Energy Saving Recommended' logo. Only products that meet strict energy efficiency criteria are eligible to display this label.

HAND FINISHING

All Liniar uPVC frames are hand-finished by skilled craftsmen ensuring an exemplary high quality finish.

Step 1

All corner contours are checked for appearance and refinished by hand using precision chisels to guarantee a smooth finish.



Step 2

The outside edges are levelled at the corners, using engineered contour blocks, to maintain the sash's square silhouette once hung into the frame.

THE PROCESS

There should always be a high level of craftsmanship involved when making a made-to-measure product, which is why we insist that each frame and sash undergoes a rigorous hand finishing procedure.

Step 3

To maintain uniformity, each corner groove is checked for an even depth and manually deepened if found to be too shallow.



Step 4

All apertures are inspected for weld build-up in the corners, with any protrusion removed to ensure tight weather seals.

What difference does this make?

In an industry dominated by machine manufacturing, nothing can beat a keen eye when it comes to the finer detail of finishing your windows or checking and that quality meets our stringent standards.



CASEMENT WINDOWS

Stylish, Secure and Energy Efficient

THE ULTIMATE WINDOW



1 Durable Hardware



Stainless steel friction stays provide enhanced security and have been tested to 20,000 cycles.

2 Bevelled or Sculptured



Standard Bevelled or optional Sculptured detail for a simpler and more contemporary look.

3 Secured by Yale



Yale high security shotbolt locking system available with Yale's 10 year insurance backed guarantee*.

4 Hinge Protection



Optional Stay Guard Elite device withstands twice the force required by Secured By Design testing.

5 Slim Sightlines



Ultra slim sightlines allow for a larger area of visible glass, providing more light and enhanced views.

6 A+ Energy Rated



Liniar's state of the art window system is engineered to be capable of achieving a WER of A+12.

Visit www.abbeywindows.co.uk/downloads to complete your extended guarantee form.



SECURITY IS OUR PRIORITY

Feel safe and secure with Yale, the world's favourite lock manufacturer.



The Yale Shootbolt Window Lock

All our Liniar uPVC windows arrive as standard with Yale shootbolt high security locking systems.

1 10 Year Mechanical Guarantee

Every Yale shootbolt window locking system is guaranteed against mechanical failure for 10 years after installation.

3 Secured by Design Accredited



Official Police Security Initiative

The Yale shootbolt locking system has been accredited with Secured by Design police preferred specification, the highest possible level of protection against forced entry.

2 £1,000 Security Guarantee

The Yale shootbolt locking system Security Guarantee means you will receive up to £1,000 towards home content insurance in the unlikely event of a break in.

* You will need to download from our website, complete and forward the application yourself once your installation is complete.

4 British Standards Institute Specification

All components are designed and manufactured to the highest standards and tested to the latest BSI security criteria pertaining to windows and doors.



The world's favourite lock

APPROVED INSTALLER

Yale is confident that windows fitted with Yale
Shootbolt locks will resist forced entry.

Should forced entry be achieved, Yale will repay
any insurance excess payable under your home
contents policy, up to a maximum of £1,000.

Paul Atkinson

Signed on behalf of Yale
I hereby confirm that the above company
is a Yale approved supplier.

For full terms and conditions please see the
YALE SECURITY GUARANTEE LEAFLET

An ASSA ABLOY Group brand

10 Year
Security
Guarantee

10 YEAR
SECURITY
GUARANTEE

10 YEAR
SECURITY
GUARANTEE

10 YEAR
SECURITY
GUARANTEE

10 YEAR
SECURITY
GUARANTEE

10 YEAR
SECURITY
GUARANTEE

10 YEAR
SECURITY
GUARANTEE

10 YEAR
SECURITY
GUARANTEE

10 YEAR
SECURITY
GUARANTEE

10 YEAR
SECURITY
GUARANTEE

10 YEAR
SECURITY
GUARANTEE

THE WORLD'S FAVOURITE

By partnering with Yale, we give you total
security and complete peace of mind.

HINGE OPTIONS

Choose from a range of hinge options to suit your own specific requirements.

Our Hinges

Our standard hinges are exclusively manufactured in Britain. Made from highly durable stainless steel they offer superb anti-corrosion qualities. Investing in authentic finish hinge fixings, we can also ensure against rusting fixings.



Easy clean hinges are standard and provide access to both faces of the side hinged window making cleaning easy and hassle free. These hinges are well-suited to properties where the outside of the window is hard to reach such as upstairs windows and high rise flats.



At least one fire egress hinge is required to habitable rooms above ground floor. It offers a larger emergency escape route in the event of a fire. Our side hinged option also slides to allow an Easy Clean facility.



WINDOW ACCESSORIES

Handle Colours

Window handles are available in a range of colours so that you can achieve your desired look.



White



Black



Chrome



Gold



Satin Silver

Trickle Vents

As the name suggests trickle vents provide extra ventilation. They are seamlessly integrated into the frames of uPVC windows and can be opened or closed to control airflow in a property. Building Regulations stipulate that trickle vents are a requirement if the new window replaces a window where a trickle vent already exists.

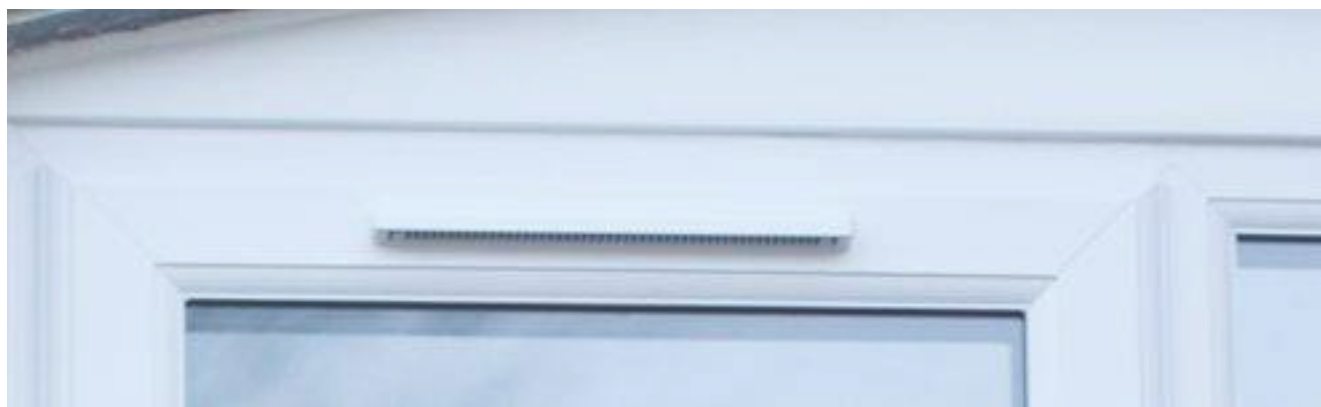

Tip – Suffering from condensation or mould? Trickle vents in a Bathroom or Kitchen can help reduce damp air issues by introducing fresh air whilst expelling damp air. **CAUTION** Damp air can create mould which can cause harmful respiratory health issues.

PROFILE COLOUR OPTIONS

Choose from a wide range of colours to best complement your property and indulge your personal taste.



White



Ivory



Mahogany



Golden Oak



Rosewood



Cream Foil



White Foil



Black Foil



Irish Oak



Cedarwood



Light Grey



Dark Grey



Basalt



Grained Anthracite



Matt Anthracite



Dark Red



Burgundy



Dark Blue



Chartwell Green



Dark Green

Colour option costs, availability and delivery periods may vary.



BOW AND BAY WINDOWS

Add character to your home with our beautiful bay and bow windows.

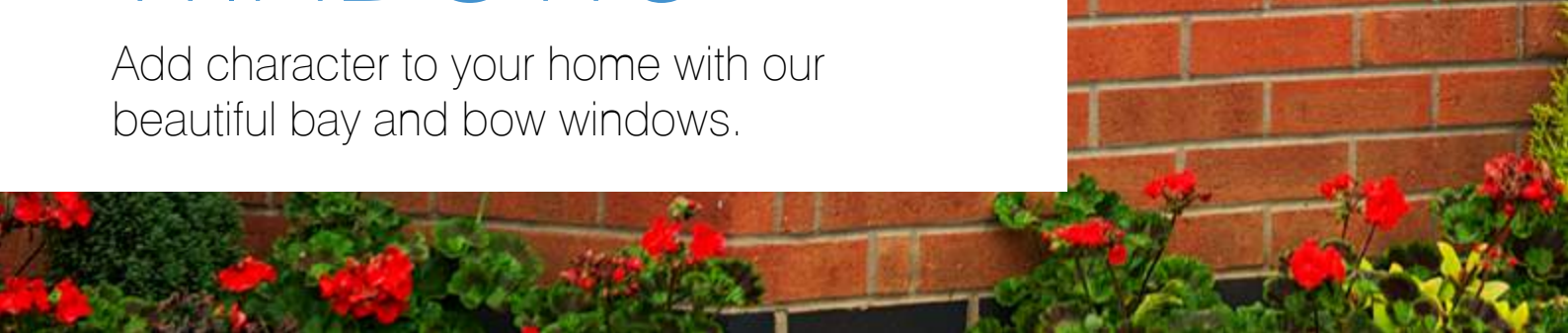



ENHANCE YOUR VIEW

Complementary Designs

Tough yet beautiful, our Bow and Bay windows are designed to suit any traditional or contemporary home.

Bow or Bay?

You can walk into a bay whilst a bow protrudes from a hole on a flat wall.

Equal Glass Area

Optional 'dummy sashes' to fixed panes create equal sightlines, enhancing the appearance of your home.

Welded One-Piece Cill

The external cill is welded on corners to create a seamless cill underneath all of the uPVC frames.

Bow Bay Conversion

Transform a flat window into a beautiful bow bay and create a heightened sense of space.

Structural Bay Poles

Hidden by decorative PVC couplings, our metal support poles are designed to carry weight from above to the bricks below our window.

Tip - Estate Agents claim bow and bay windows add to the saleability and value of a property



TILT AND TURN WINDOWS

Versatile tilt and turn windows are both attractive and functional.

SAFE AND SECURE



1 Secure Ventilation



Convenient inward opening 'tilt-only' function provides additional ventilation.

2 Integrated Hardware



UNI-JET concealed gearing is more secure and attractive than out-dated face-fix gearing.

3 European Aesthetic



Clean straight lines and crisp, concise detailing combine with fully integrated hardware.

4 Corrosion Resistance



'FerGUard* silver' surface coating ensures long-term corrosion protection at no extra cost.

5 Quick-To-Clean



90° opening allows easy exterior access, ideal for cleaning or fire escape from high windows.

6 Uninterrupted Seal



A continuous rebate gasket helps prevent condensation whilst enhancing sound-proofing.



VERTICAL SLIDERS

Maintain a traditional look for your home with our elegant uPVC vertical sliding sash windows.

A MODERN CLASSIC

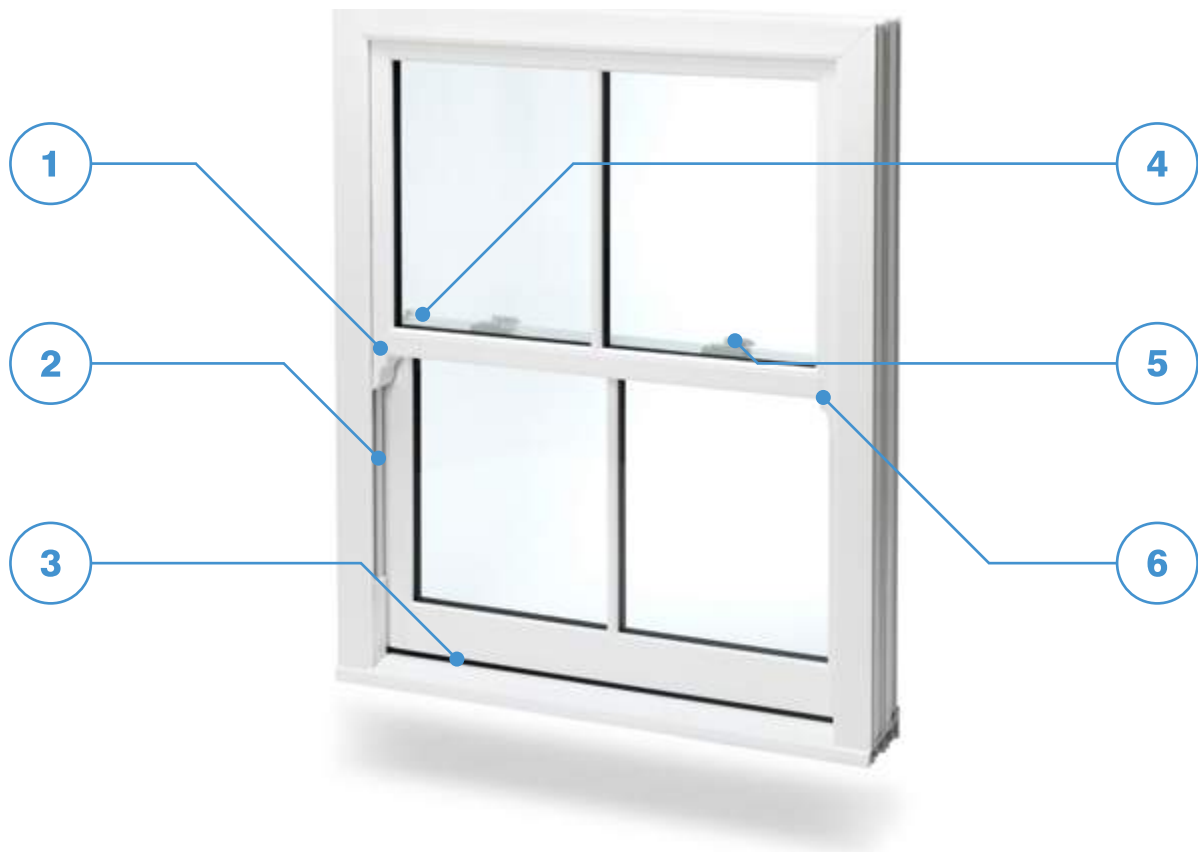

1 Sash Horns



Optional decorative 'run through' sash horns carefully emulate the traditional look of sliding sash windows

2 Spring Balance Mechanism



Spiral balances counteract the weight of the sliding sash for smooth and effortless operation.

3 Concealed Gaskets



Low-level PCE gaskets provide protection from the elements whilst remaining out of view.

4 Keep Children Safe



Restrictors can be fitted to stop the bottom sash sliding fully, keeping your children safe.

5 High Security



uPVC vertical sliding sash windows are available with high security cam locks for your peace of mind.

6 Tilt Function



Built in pivot bar enables sashes to tilt inwards for cleaning or extra ventilation at the push of a button.

A close-up, high-angle photograph of a white plastic window sash horn mechanism. The image shows the intricate details of the window's internal structure, including the curved sash horn and the surrounding frame. The lighting is soft, highlighting the smooth texture of the plastic. A blue decorative element is visible in the top left corner, and a thin horizontal line is present at the top of the page.

SASH HORN WINDOWS

The refined alternative to
sliding sash windows.

TRADITIONAL STYLE

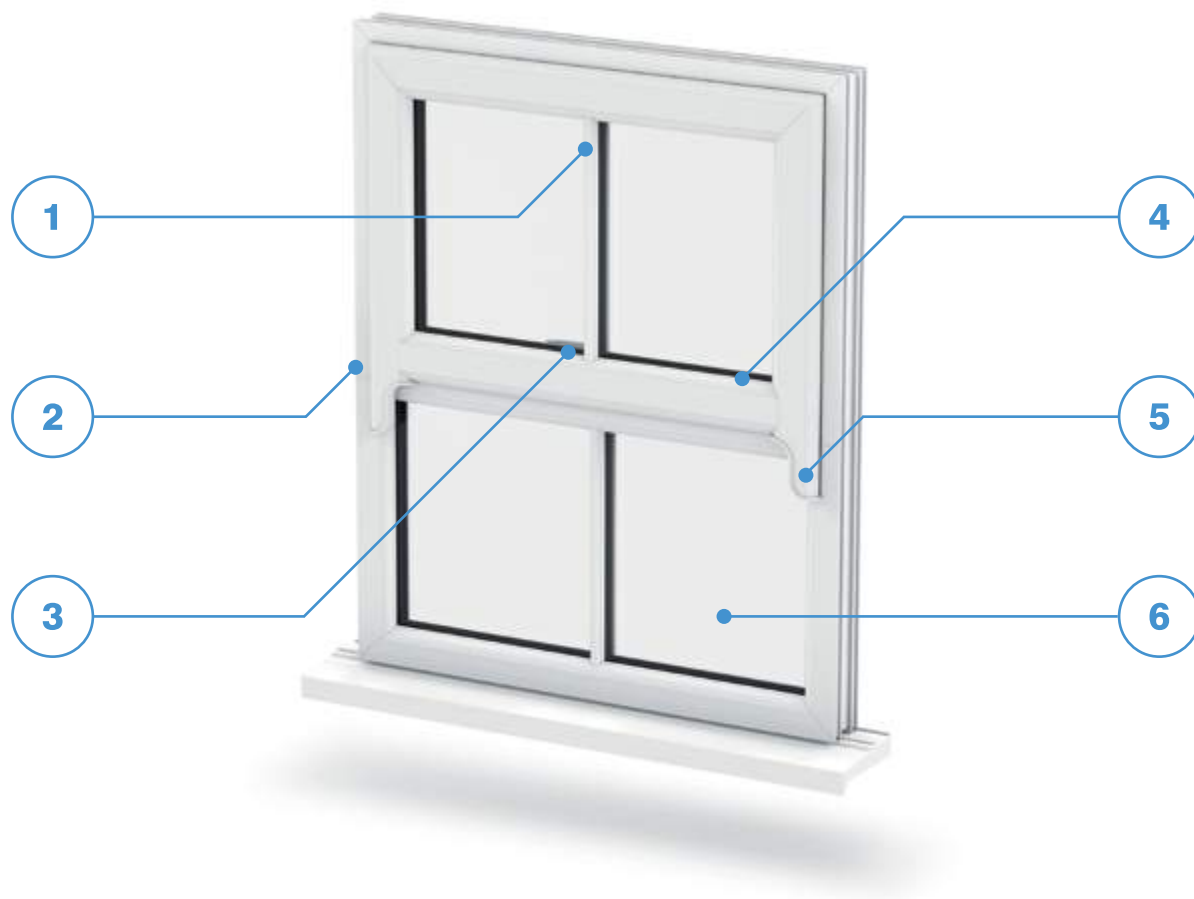

1 Authentic Looks



Preserve the look of wooden box sash windows and maintain the integrity of your property.

2 Hand Finishing



Every window undergoes stringent hand finishing for an unrivalled level of product quality.

3 Security Assured



Windows with Yale shootbolt locking are covered by a money-back promise in the event of a break-in.

4 Yale 10 Year Guarantee



Yale shootbolt locking systems are guaranteed against mechanical failure for 10 years.

5 Integrated Horns



Our single piece uPVC sash horns avoid the dirt trap of other screw on plastic alternatives.

6 Superior Weather Sealing

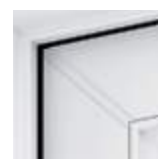

Continuous sash seal (incorporating special horn gaskets) gives protection against the harshest conditions.



FRENCH CASEMENT WINDOWS

Really open up your property with our beautiful French casement windows.

A WIDER VIEW



1 Floating Mullion



When opened fully, one sash carries the central mullion for a completely unrestricted view.

2 Controlled Ventilation



The primary sash can be opened independently from the secondary sash for variable ventilation.

3 90° Hinge Opening



Sashes open 90° (with Egress Hinges), Creating a greater feeling of space whilst letting in more light.

4 Fire Escape



French casements are Part B* compliant, ideal for narrow openings that need to be fire escapes.

5 Environmentally Friendly



Like all our uPVC products, French casements are 100% lead free and 100% recyclable.

6 Easy to Clean



Easy-clean hinge option makes our French casement windows extremely low maintenance.

Tip - A Room with a view? These windows are ideal for a unrestricted vista.

* Building Regulations 2010, Approved Document B (Fire Safety) pertaining to work carried out in England.



FLUSH SASH WINDOWS

Timber or uPVC? Our Flush Sash Window Range will make you look twice..

TIMELESS AESTHETICS

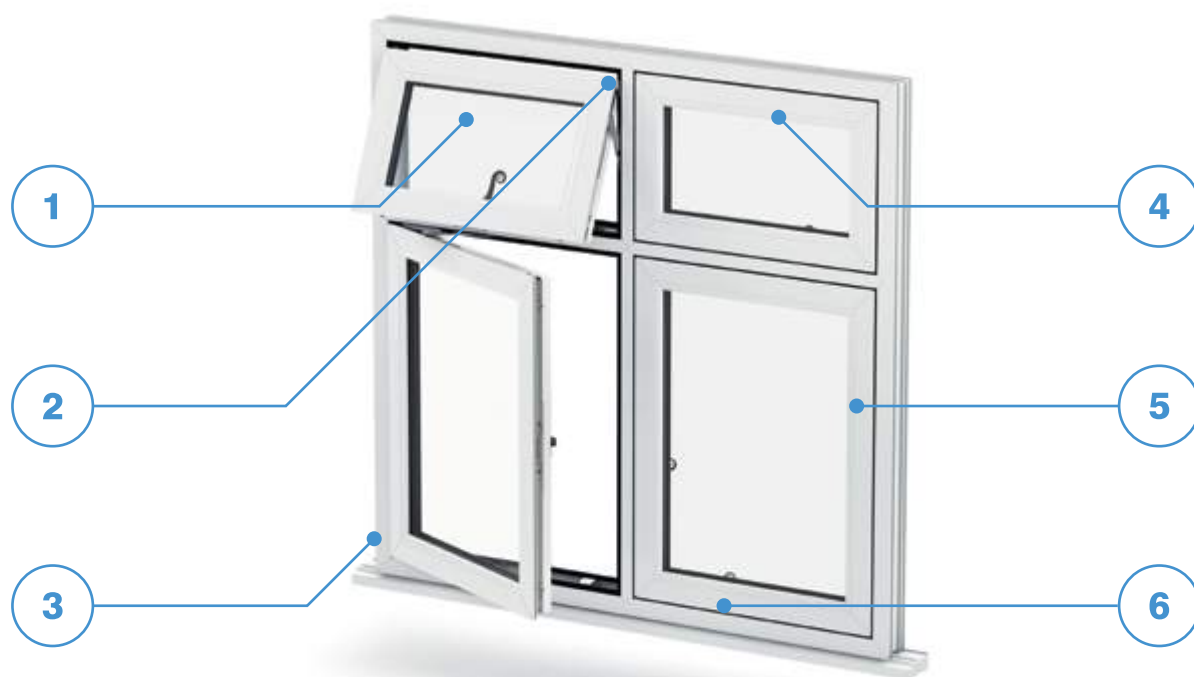

1 Beautiful Aesthetics



The frame and sash sit flush when closed, recreating the look of traditional timber joinery.

2 Colour Perfect



Retain or enhance a period or modern property with a wide range of colour options.

3 Multi-Chambered



Manufactured using multi-chambered uPVC Liniar profile for optimum thermal efficiency.

4 Tailored to You



Customise our flush sash windows with key-locking monkey tail handles and dummy stays.

5 Yale Locking



Yale shootbolt locking windows are covered by a money-back promise in the event of a break-in.

6 Low Maintenance



The traditional look of timber without the maintenance. You'll never need to sand, treat or paint them.

Tip – Differing frame shapes allows us to create larger glass sizes, more reminiscent of traditional timber windows.

ASTRAGAL BAR

When the detail is everything..

What are they and how do they work?

Design & Consultation



A member of our team will talk through the astragal bar arrangement with you to ensure that the layout is complementary to your chosen window style and the look of your property. This can (if you require) then turned into a 'schematic' drawing of the windows.

Manufacture



During manufacture, a grid of rigid plastic or aluminium spacer bars is positioned within the sealed units of the windows and securely held in place by concealed fixings. The grid is sandwiched between the two panes of glass and the unit is then sealed air-tight.

Finished Product



Decorative uPVC bars are then applied to the internal and external faces of the window so that the surface of the glass underneath becomes hidden from view and the bars appear to intersect through the entire window. This creates the illusion of many smaller individual panes, replicating the look of a traditional Georgian window in a variety of colours to match the window or door.

AUTHENTIC LOOK

Nothing compares to the genuine look and feel of well executed Astragal and Georgian bar.



Astragal Bar

We use environmentally friendly 20mm Linar profile for our astragal bars which like all our uPVC window frames is 100% lead free and 100% recyclable.

Run through mullion sections and extremely precise end-milling creates an aesthetic which faithfully replicates the look of real wood without any of the upkeep.



Georgian Bar

The ever-popular Internal Georgian bars option will add to your windows an air of sophistication.

The bars sit within the sealed glass unit to provide an elegant and refined look with no cleaning required. Georgian bars are an attractive and economic alternative to astragal bars.

- MORE SECURE**
- BETTER INSULATION**
(Comparable with Triple Glazing)
- BETTER SOUND INSULATIONS**
(Better than Double and Triple)
- UV FILTERS**
(Reducing Harmful UV Rays)



HOMEGUARD

The amazing alternative to standard double and triple glazing.

The Homeguard system uses a standard double glazed frame, with an upgraded 6.4mm clear laminated glass outer pane*, and a 4mm inner pane glass unit. This revolutionary but tried and tested system provides more combined enhanced security, heat and acoustic efficiency than triple glazing, at a lower cost.

***In some cases we will need to install this to the internal pane**

Why Choose a Homeguard System?

Insulation

Homeguard increases the WER Rating to A+ with our standard Liniar window and achieves U-Values as low as 1.2 W/m².K - that's almost equal to standard triple glazing.



Security

A key element of the Police 'Secured by Design' specification, laminated is the same glass as used in your front car windscreen. It provides a substantial barrier against burglars as it holds together once broken. And Burglars hate anything that slows them down, makes a noise and is dangerous for them to try and enter through.



Sound

In 30 years of glazing TV and Radio studios Abbey discovered that by using two different glass thicknesses we confused sound waves. The result is that Homeguard sound insulation is better than standard double or triple glazing.



Whether you choose Homeguard downstairs at the rear of the house for security, a bedroom for noise reduction or all around benefits, Homeguard offers great all round value for money.

Any rating or figure given is based upon a set and sized standard Liniar PVC window. Any differing profiles or alternative products may not provide the exact same values. More accurate values may be available but are not guaranteed.

6.4mm glass may be substituted on occasion for 6.8mm glass.

SEE THE BENEFITS

Take a look at how Homeguard can improve your home.

| BENEFITS | Our A Rated Double Glazing | Triple Glazing | Homeguard |
|---|--|---|---|
| Glass specification | 4mm annealed - 20mm warm edge spacer with argon gas - 4mm annealed Planitherm+ | 4mm annealed - 12mm warm edge spacers with argon gas – 4mm clear toughened centre, 4mm annealed Planitherm+ | 6.4mm clear laminated - 18mm warm edge spacer with argon gas - 4mm annealed Planitherm+ |
| Thermal Rating (Frame U Value) Source- Climatec Test data – Lowest is Best | 1.4U | 1.15U | 1.2U |
| Noise Reduction How many decibel reduction Source- Climatec Test data – Highest is Best | 28RWDB | 32RWDB | 35RWDB |
| Security Enhanced | No | No | Yes Using 6.4mm laminated to exterior. Key element of Secured by Design Police Approval. |
| Security Compromised | No | Possibly Using a thicker glass unit requires using a thinner glazing bead to secure the glass. | No We use the same thickness glass as our Std A Rated window |
| Safety Enhanced | No | No (although safety glass is sandwiched to middle pane). | Yes |
| Clarity of Vision All glass is tinted. Becomes darker as glass gets thicker. | Std Pilkington K S is used as clearer than other products. | Worse as 50% more glass added. | 15% thinner than Triple Glazing |
| Hardware Upgrades Req'd Increasing cost to accept heavier glass | No | Yes Heavy duty hinges req'd & possibly more reinforcement. | No |
| Extended Delivery | No | No | No |
| Quality | StdW | Worse Increasing number of sandwiched surfaces increases possibility of marks inside (even if within GGF standards) | Std |
| Cost Implication | StdG | Glass cost doubles Manufacturing time triples with two seals. Replacement costs higher and extra weight for fitters to lift. | Minimal increase to upgrade |
| Where would ABBEY recommend this product? | Almost any application in UK | Northern Hemisphere Climates with upgrades to glass when insulation is more critical. | Any window, door or conservatory where a benefit above is preferred. |
| OutcomeS | Standard window offers good value for money all round. | Increased insulation in this climate will not provide a return on investment. | Offers great all round value for money. |

Any rating or figure given is based upon a set and sized standard Linear PVC window. Any differing profiles or alternative products may not provide the exact same values. More accurate values may be available but are not guaranteed.
6.4mm glass may be substituted on occasion for 6.8mm glass.

OBSCURE GLASS

Achieve privacy and style.

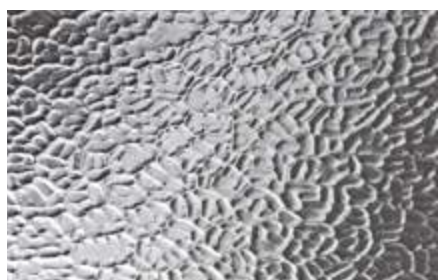

Arctic™



Autumn™



Chantilly™



Charcoal Sticks™



Contora™



Cotswold™

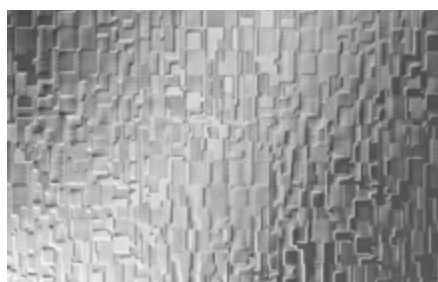

Digital™



Everglade™



Flemish™

Warwick Glass is a Premium Range cost option. Size restrictions apply to Obscure glass.



PILKINGTON

If you are looking for extra privacy but don't want to lose light within your rooms then obscure glass is the solution. There are a wide range of obscure glass options available to give you the exact level of privacy you require.

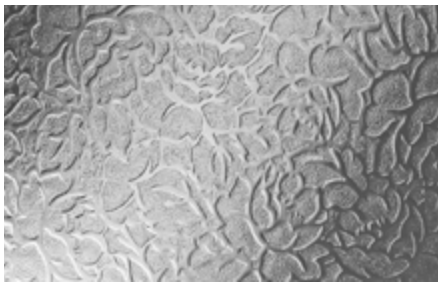

Florielle™

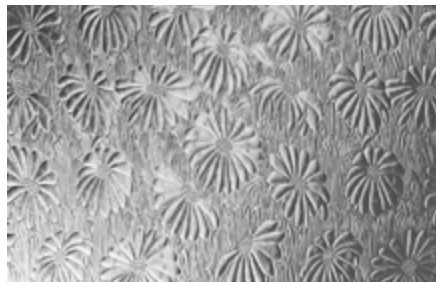

Mayflower™

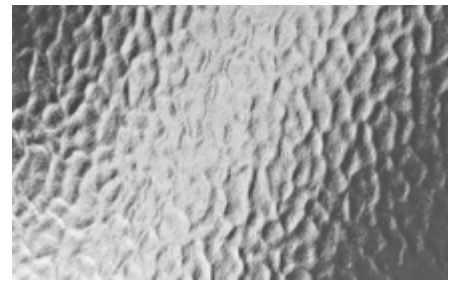

Minster™



Oak™



Pelerine™

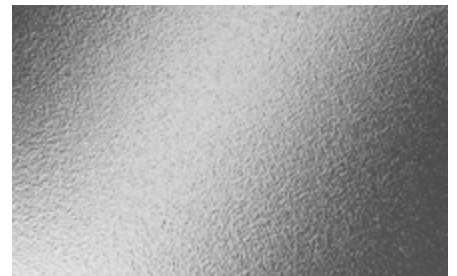

Stippolyte™



Sycamore™

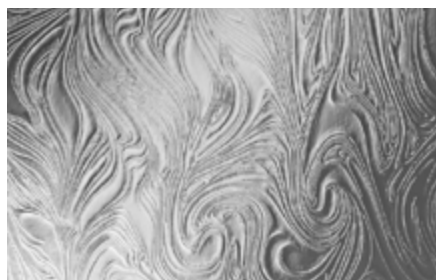

Taffeta™



Warwick™

Each pattern brand name is a trademark of Pilkington PLC | Images may only be reproduced by permission of Pilkington PLC | All images are copyright of Pilkington PLC

LEADED GLASS

Enhance the look of your windows with a choice of leaded styles.



Diamond Leads

Choose diamond leaded windows for an elegant and traditional look.



Rectangular Leads

Square leads will add a touch of sophistication to your windows.

With a history of designing and producing Leaded Designs, Abbey also offer Queen Anne and bespoke designs, paying attention to the finest detail including lead sizes and shape.

Tip - Lead is produced 'bright' and initially supplied shiny but this can be prone to oxidisation (rusting) which leaves a white deposit on the glass of leaded windows. To avoid this, ask your supplier to have the lead darkened. That's the type detail Abbey apply – as standard.

DECORATIVE GLASS

Style your windows with a pattern or design that really makes a statement.

Leaded Decorative Glass

A skilled craftsman will make the lead pattern based upon a template created from your bespoke design. The lead is then shaped using this pattern. Our leaded decorative windows are a beautiful addition to any home.



Bevelled Decorative Glass

Choose from a huge range of beautiful bevelled glass designs that will help you to create your own individual style.



Sandblasted Decorative Glass

Sandblasted or Etched designs can cover the whole area or produce a feature using sandblasting, acid etching or vinyl films.





ENTRANCE DOORS

Gain security, weather-proofing and durability with a uPVC panelled entrance door.

MAKE AN IMPACT

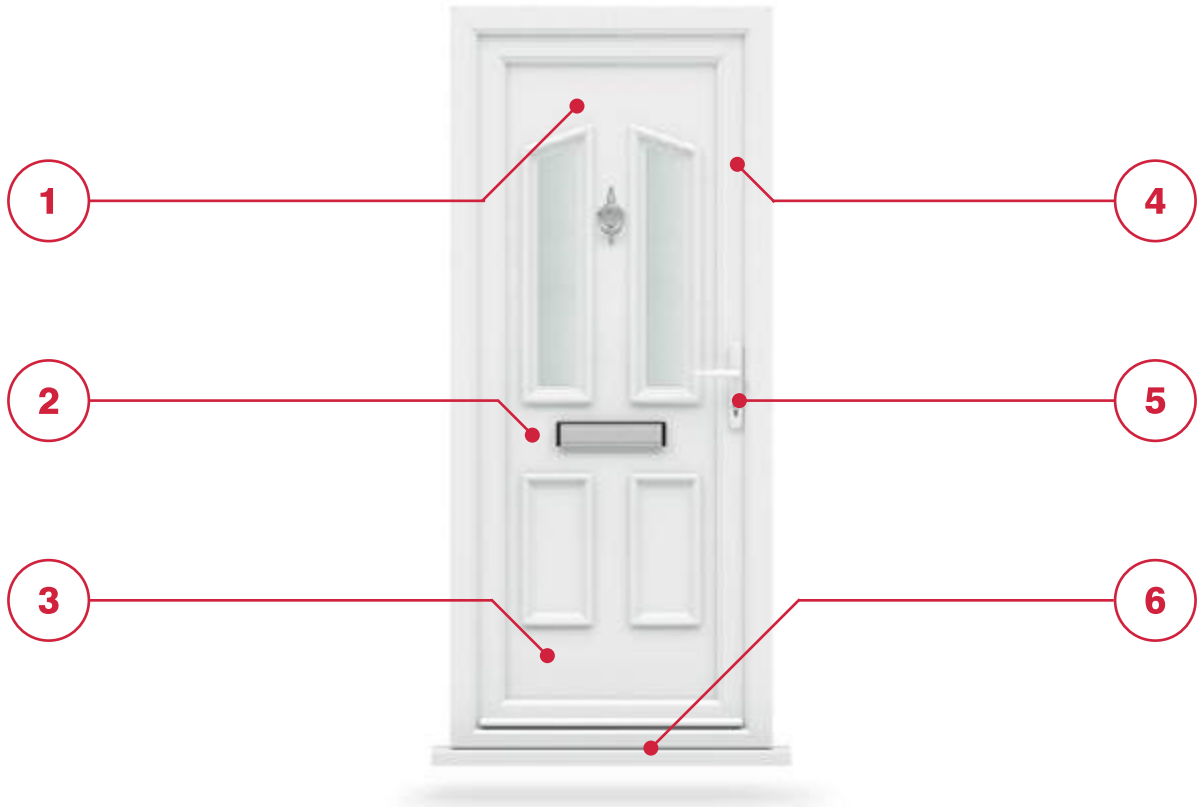

1 Unbeatable Choice



Style your door to your own personal taste with our wide range of panel designs and glazing options.

2 Secured By Design



The optional 'SBD Accredited' pack for the ultimate in door security is available on all our doors.

3 Insurance Backed



Our doors come with the promise of £1,000 towards your contents policy in the unlikely event of a break-in.

4 Double Rebated



Outer frame profiles feature a double rebated design for extra defence against Mother Nature.

5 Britain's Favourite Lock



Yale Lockmaster® multipoint locks, the UK's top selling door lock, are fitted into every single PVC door we install.

6 Threshold Options



Choose from standard or low uPVC threshold, or a standard or Part M* compliant aluminium threshold.

* Building Regulations 2010, Approved Document M (Access to and use of buildings) pertaining to work carried out in England.



COMPOSITE DOORS

Make a lasting impression with
an elegant composite door.

ELEGANT & STRONG

Timeless Design

Our exceptional range of composite doors reproduce the traditional essence of timber products.



Resilient & Solid

We feel a solid core represents a stronger door than any foam or polystyrene alternative door.

Express Yourself

Achieve exactly the look you desire with our vast selection of colours, style and decorative glass options.

Maximum Security

The high security insurance approved PAS 24 locking systems promise to offer you the very best in home protection.

Low Maintenance

Easy to maintain as they don't need painting! They're also guaranteed not to rot, warp or split.

Weather Resistant

Double sealed keep the cold and rain out and the warmth generated by your home's central heating locked-in.

Tip - Our show centre features a large number of doors plus full range brochures (which are also found at abbeywindows.co.uk).





BACK DOORS

Our back doors provide security,
functionality and weather-sealing.

INCREDIBLY ROBUST

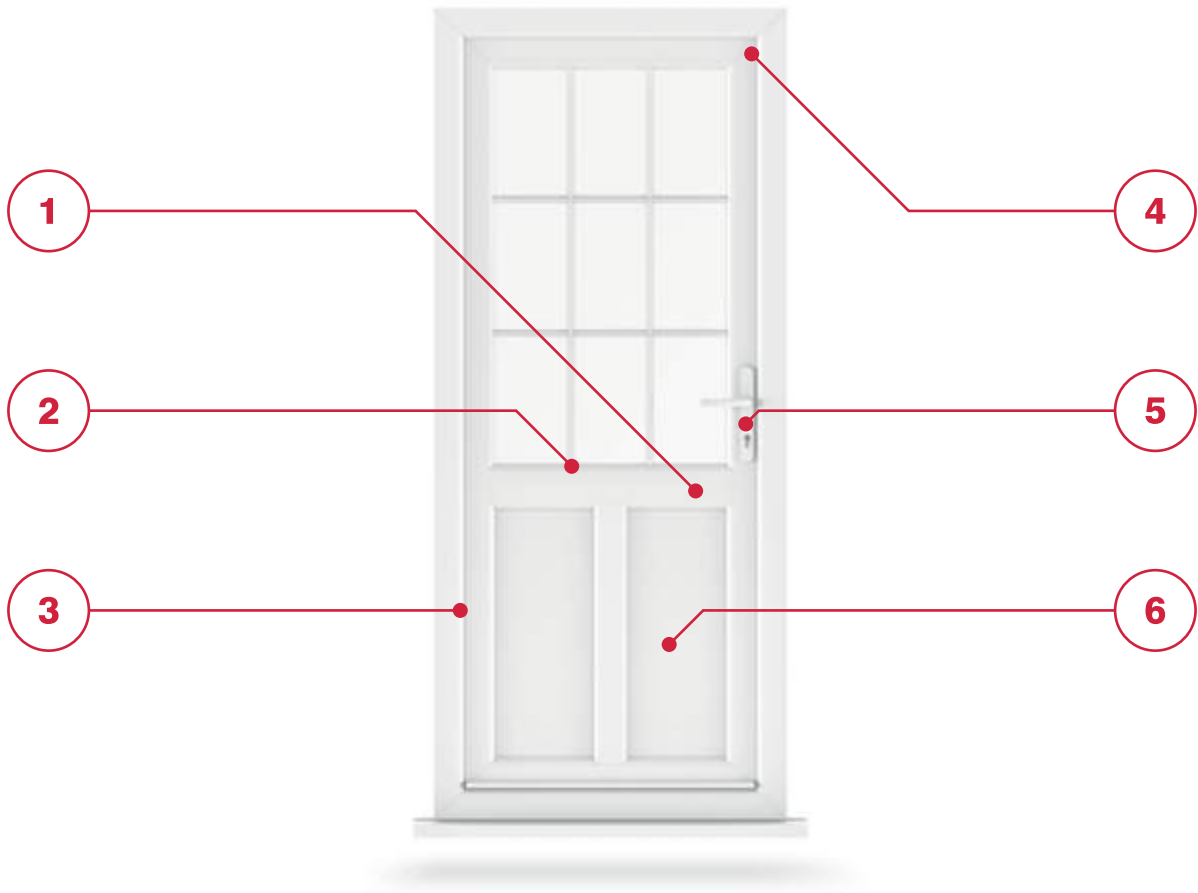

1 Complementary



In many designs we can marry our doors, colours and glass choices to any of your window preferences.

2 Universal Rebate



A common rebate detail on all products means doors can have our astragal bar glass decoration too!

3 Superior Sealing



Our back doors have superior gaskets, providing protection from the harshest of weather conditions.

4 Hand Finished



Our back doors are carefully hand finished by skilled craftsmen for an unbeatable, high quality, aesthetic.

5 Yale Guarantee



All doors fitted with Yale Lockmaster® are guaranteed against mechanical failure for 10 years.

6 Panel Choices



Choose from a range of raised half, quarter and flat panels with fully integrated pet entrance options.



STABLE DOORS

Our superb range of Composite & uPVC Stable Doors offer versatility, style and security.

MULTI-FUNCTIONAL

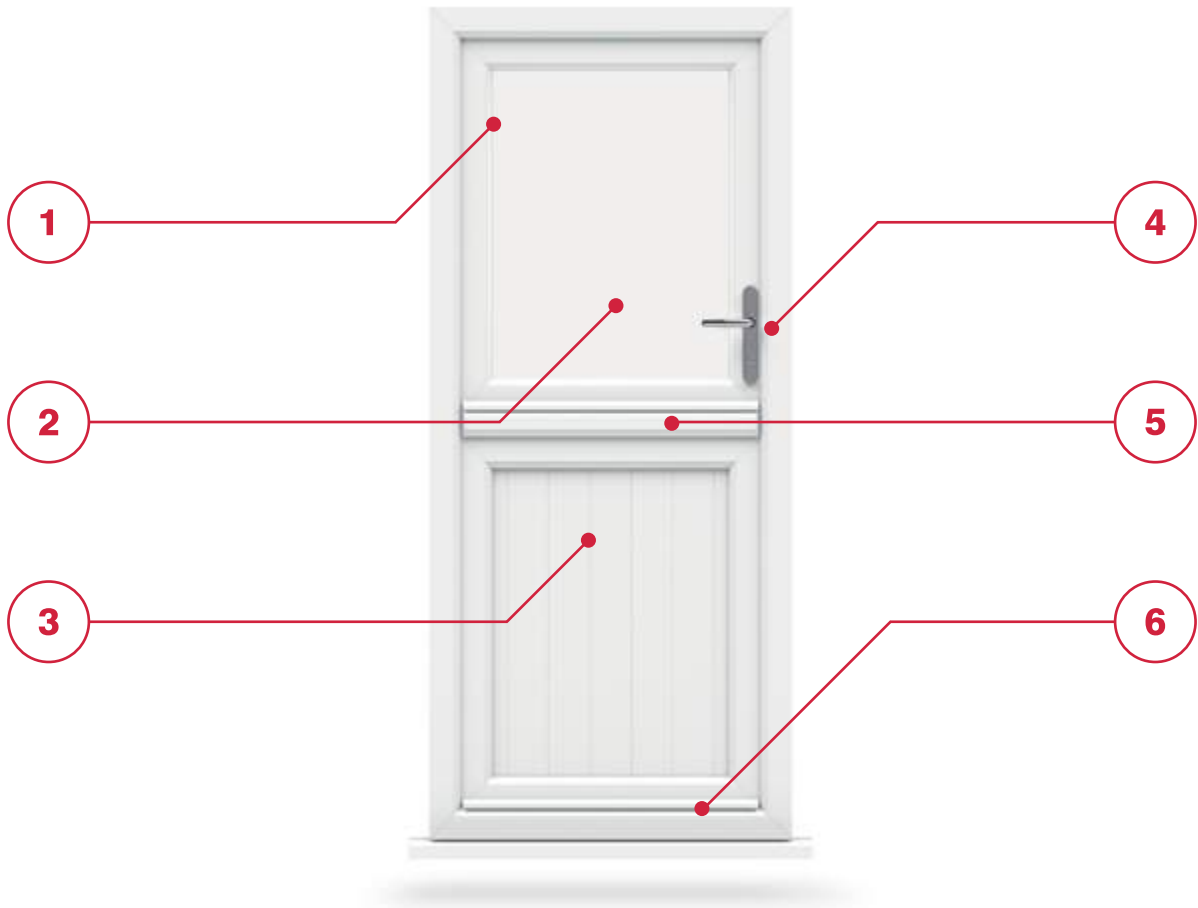

1 Useful



Upgrade PVC doors with an additional tilt facility and enjoy the ultimate in flexibility of operation.

2 Convenient



Sashes disengage to allow the top half of the door to move independently from the bottom.

3 Versatility



With the two sashes coupled together the product functions as a normal entrance door.

4 High Security



For your peace of mind high security locking systems are fitted as standard.

5 Double Drip Bars



Drip bars are fitted to both sashes of all our stable doors, as standard, to prevent water ingress.

6 Low Threshold



Low threshold and wheelchair threshold options are available on our stable doors.

See our brochures or website for our full range of composite stable doors



FRENCH DOORS

Connect your home to your garden with our
stunning uPVC French Doors.

CONTINENTAL FLAIR

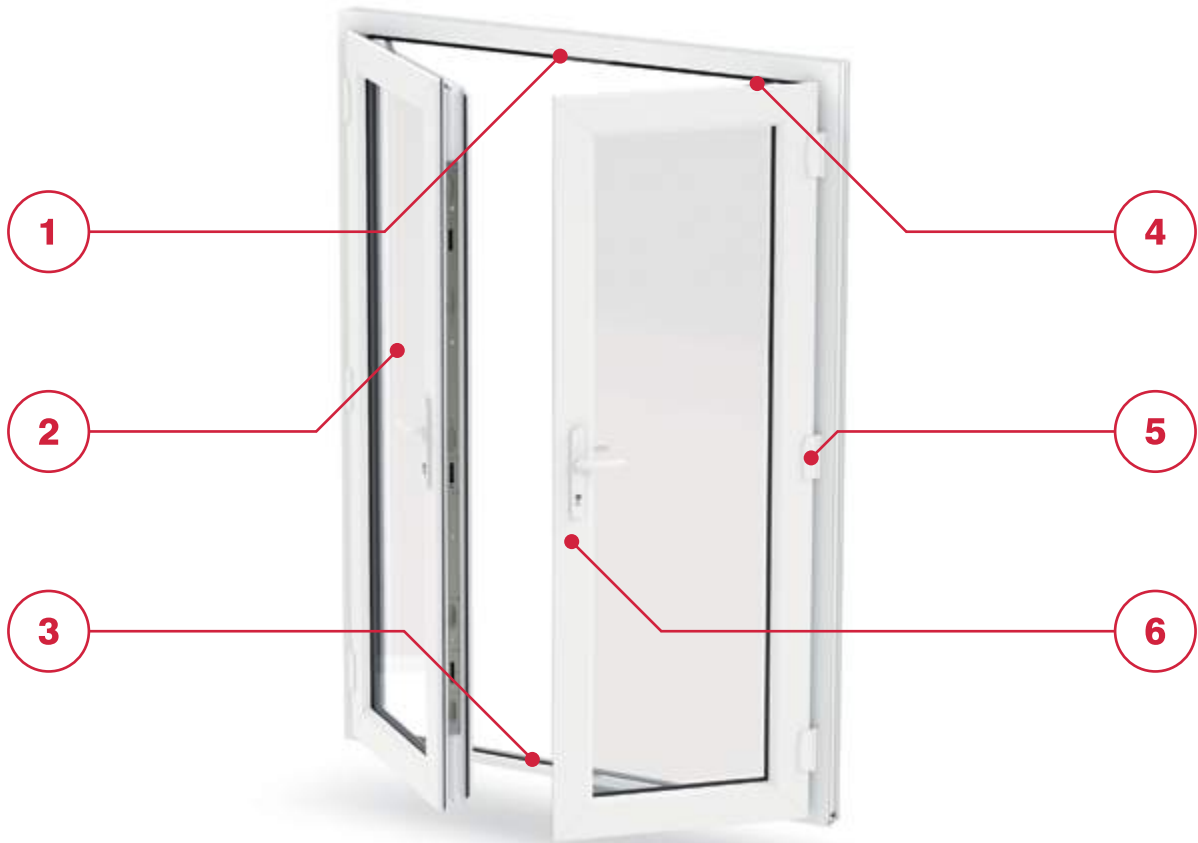

1 Security Shootbolts



Yale Lockmaster® multipoint lock with added high security shootbolts supplied as standard.

2 Passive Locking



Lock and handles on the second door for easier operation than cumbersome top and bottom shootbolts.

3 Milled Threshold



Exclusive milled frame-to-threshold jointing system eliminates moulded plastic end caps.

4 Door Restrictors



Optional fitted restrictors avert damage by preventing opening past a set angle.

5 Hinges by SFS Intec



Available in 8 colours, our premium range of Italian 'Dynamic 2D' door hinges offer a slimline design.

6 Cohesive Colour



Great collection of RENOLIT foils available across our entire range for total consistency.



PATIO DOORS

Enhance your home with our revolutionary uPVC sliding patio doors.

STYLISH & SECURE



1 Kat Sliding uPVC Doors



We offer Kat's premium uPVC sliding patio door, in a variety of styles and colours.

2 Security Locking



Our Elegance door includes the ability to lock a door partially open.

3 Smooth System

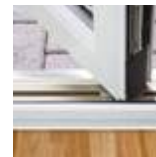

Durable stainless steel track and smooth running tandem rollers.

4 Maximum Security



High tensile steel shootbolts provide additional locking points at both head and cill.

5 Child Friendly



The locking mechanism has a 'finger-traps-free' design to protect small children.

6 Clever Thresholds



Wrap-over design prevents scuff marks. Low threshold and ramp also available.



BI-FOLD DOORS

Gain panoramic views of the outside and increased natural light inside with our beautiful bi-fold doors.

A STUNNING ADDITION

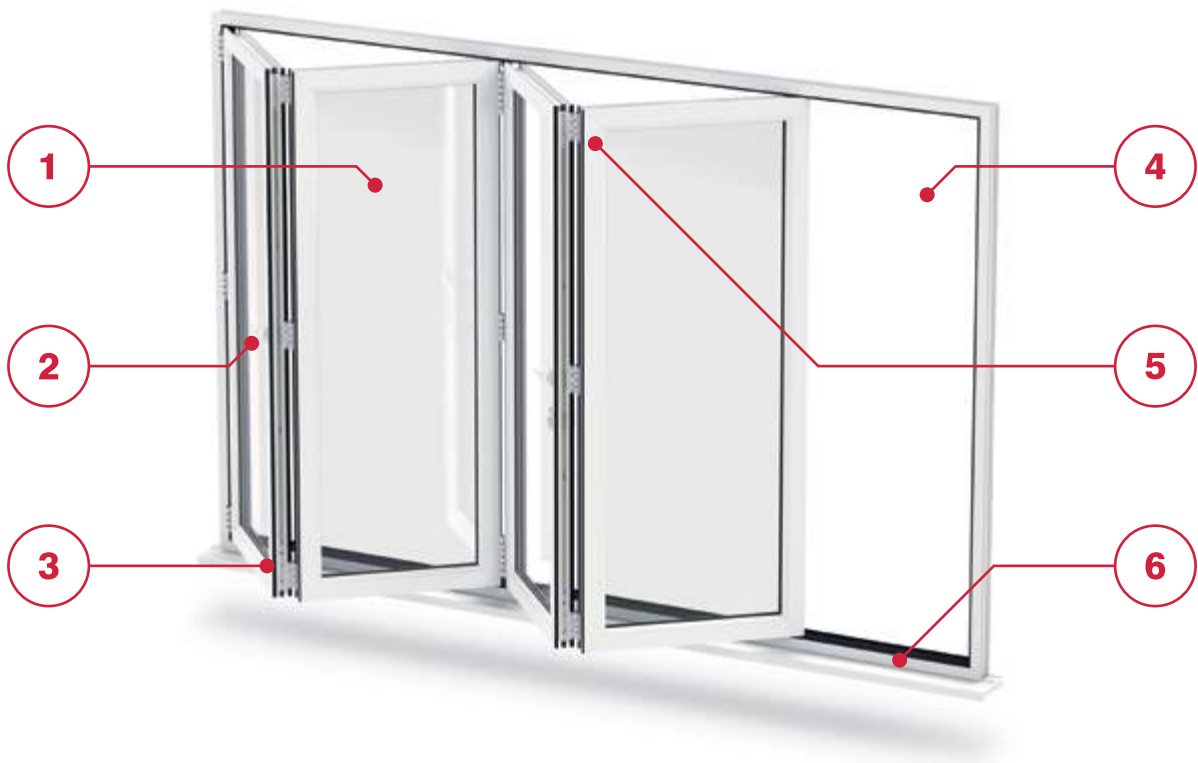

1 Flexible Configuration



With styles from 2-7 panes and various fold configurations, tailor your doors to suit your needs perfectly.

2 Unified Components



Patented Liniar hardware works harmoniously with the range of Liniar energy efficient profiles.

3 Concealed Hardware



In-board mounted stainless steel track conceals hardware, for a clean and attractive finish.

4 Open Up Your Space



Slim outer frame ensures that up to 90% of the aperture remains unobstructed when fully open.

5 Aluminium Alternative



Our innovative uPVC bi-fold doors are robust and reliable in the best and worst of British weather.

6 Ultra-Low Threshold



Available with an aluminium 24mm low threshold and optional wheelchair access ramp.



Our Origin range of aluminium doors offer a smooth and beautiful alternative with doors up to 12 meters wide.

DOOR ACCESSORIES

Your door, tailored to your home.

Knockers



White



Black



Chrome



Gold



Silver



Cat Flaps



Spy Holes

Hinge Colours



White on White



Silver on
Irish Oak



Smoked on
Anthracite



Gold on
Cream Foil



Black on
Chartwell Green

DOOR LETTERBOXES

White



Black



Chrome



Gold



Silver



LOCKMASTER®



Britain's best selling multi-point door lock

10 Year Guarantee

The multi-point Yale Lockmaster® comes as standard on all our entrance doors, providing your home with the protection it deserves.

Available in both split spindle (front door) and straight spindle (back door) configurations the Yale Lockmaster® comes with a 10 year manufacturer's guarantee against mechanical breakdown. Visit www.abbeywindows.co.uk/brochures to complete your extended guarantee form.

Pre-Compression Roller

Pre-compression roller cams ensure smooth operation and maximise weather proofing.



Anti-lift Pins

Anti-lift pins slot into the frame preventing the door from being moved or lifted.



Centre Latch & Hook

The central latch combines with an anti-separation hook to create a solid and rigid locking point.



Claw Hooks

Claw hooks grip the door sash to the frame for extra strength and solidity.





THE WORLD'S FAVOURITE

By partnering with Yale, we give you total security and complete peace of mind.

PROFILE OPTIONS

Get creative with Liniar's range of stylish uPVC profiles.

Liniar's revolutionary multi-chambered profile comes in two styles. The standard Sculptured profile adds that extra touch of elegance to your home with traditional decorative detailing. Whilst the Chamfered system offers a more subtle approach with a clean and design that suits modern and traditional homes alike.

No matter which profile options you prefer, Abbey Windows can work with you to design your dream double glazing.

Liniar uPVC Profiles

Sculptured

Our uPVC Liniar windows are offered as standard in our Sculptured 70mm frame. This design is ideally suited to homeowners looking to use the profile shape to create 'shadow lines' that break up the plastic surface area creating the feel of a thinner frame. An ideal solution for matching traditional timber frames or a contemporary feel, all the benefits of a state of the art uPVC profile.

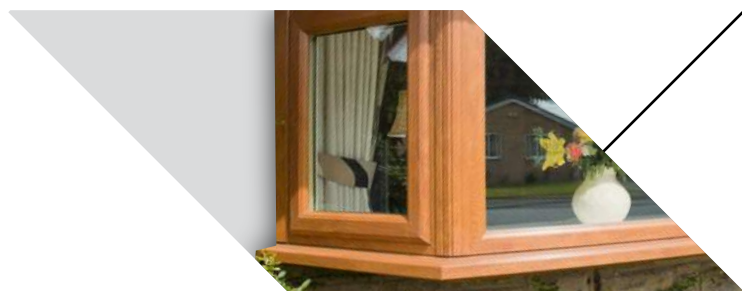

Chamfered

Abbey's Liniar Chamfered or 'Bevelled' 70mm PVCu profile provides a simplistic finish emulating either traditional putty lines or clean surfaces for a modern window effect. Perfect for a wide range of window projects in Thames Valley area.



Flush Casement

Flush casement windows are nothing new. With 500 year old timber examples still in use, the Liniar Flush frame has been sympathetically designed to emulate period wooden windows whilst offering the low maintenance and energy saving benefits of plastic.

COLOUR OPTIONS

Create the windows and doors of your dreams with our range of stylish colour options.

At Abbey Windows we supply and install the highest quality Liniar PVC products which are available in a wide range of standard and competitively priced colours and profile options; from traditional White and Ivory to realistic Woodgrain finishes, and increasingly more popular choices like Chartwell Green and anthracite grey, we have the perfect palette to suit your home in the Thames Valley area.

And for the bespoke service, we offer a 'Painted Service'. Virtually any colour is achieved using paint solutions that bond into your windows for a permanent colour enhancement.

Once you've chosen your preferred colour and finish, you can then select your profile shape to add a personal touch.



White & White Foil
● ●

● Sculptured ● Chamfered



Cream & Cream Foil
●



Chartwell Green
●



7016 Grey
●



Black
● ●



Irish Oak
●



Golden Oak
● ●



Mahogany
● ●



Rosewood
● ●



CONSERVATORIES

Extend your home with a beautiful uPVC conservatory.



DESIGN OPTIONS



Victorian

The traditional design includes a three or five facet bay that projects out giving an attractive curved outline and excellent outside views. The beautiful Cresting that line the roof and finials add a lavish finishing touch. Our energy saving glasses provide excellent winter insulation.



Lean-To

Popular and cost-effective, lean-to conservatories are ideal if you have limited space and budget. Lean-to's can also be incorporated into other designs to create a 'T' or 'P' shaped conservatory. They are also perfect for bungalows and homes where there can be height restrictions.



Edwardian

Edwardian conservatories (sloping front roof) are a striking addition to your home. Their square design makes the most of available space and allows for sunlight which we can control with solar glasses.



Gable-Ended and Pavilion

The high-angled roof maximises sunlight creating a warm and airy atmosphere inside. The gable-end often incorporates a 'rising-sun' design, a stylish and charming feature.



Bespoke

Combining the lean-to conservatory with one of the other styles to create a P-shaped structure, these conservatories can be perfect if you have an unconventional building space.



Orangery

Offering more privacy than other conservatories, an orangery is a truly luxurious way to extend your home. Grand but not flashy, an orangery will provide you with a beautiful new living space.



ROOF OPTIONS

Tailor your roof to your conservatory.

CHOICES



Glass

- A glass roof provides the ultimate in solar control with a choice of different colour tints and solar reflective coatings.
- Glass is a better choice than polycarbonate for noise reduction.
- Self cleaning glass is supplied as standard.



Polycarbonate

- Double thickness, chambered up to 35 mm.
- The economic choice.
- Available in clear, opal, bronze and bronze-opal.

Your Designer will assist you with further options such as rooflights, lighting and aesthetic finishing products which could create a wow factor from a conservatory.



CONSERVATORY PROCESS

What you need to know.

A STEP BY STEP GUIDE



1. Quotation

We will discuss conservatory options with you to find the style that best suits you and your property. We will then provide you with a free, no obligation quote.



2. Design Process

We will design and produce technical drawings so that you are able to visualise your new conservatory before a single brick has been laid or window installed.



3. Technical Survey

A technical survey is carried out by one of our professional surveyors. They will visit the site in order to take accurate measurements to be used for bespoke manufacturing.



4. Plans

We will draw up a groundwork plan and a detailed structural plan using the details gathered during the technical survey. We will use this to build your conservatory.



5. Planning Permission

Usually planning permission is not required as a conservatory is a 'permitted development'. (We can carry out the planning permission process on your behalf if required.)



6. Building Work

We will lay the foundations for your new conservatory. Once these are in place we will build the base and walls that form a solid support for the uPVC structure.



7. Roof Structure

Once the walls, windows and roof are in place we can move to complete other the finals stages such as plastering and electrics.



8. Your New Conservatory

Your new conservatory is ready for you to enjoy. It's time to move your furniture in and sit back and relax in your brand new living space.



9. Guarantee

All of our conservatories are covered by a comprehensive guarantee. Why not start planning your conservatory today?

GUARANTEED PEACE OF MIND

With the Abbey perfect choice...





Liniar is the fastest growing uPVC profile extruder, manufacturing the most technically advanced uPVC window system in the UK. Designed in the 21st Century to meet today's exacting challenges, Liniar's 100% British made profile provides superior energy efficiency and is guaranteed for 10 years.

Being 100% lead free and recyclable it is extremely environmentally friendly. Therefore you can have complete confidence in the supply and installation of our industry leading window, door and conservatory products.



Feel safe and secure with Yale, the world's favourite maximum security lock manufacturer. All of our products have Yale high security locking systems as standard. We are official Yale Approved Installers, so you can benefit from Yale's 10 year, £1000 Security Guarantee on all high security locking systems.



Furthermore, our manufacturing partner, TruFrame, have an unrivalled level of excellence in manufacturing hand-finished uPVC frames, spanning over 20 years. Since partnering with Liniar, they have grown into one of the largest manufacturers of uPVC in the UK.

They in turn, guarantee all aspects of the manufacturing process, only supplying the very best double glazing installers. Our own company has an excellent local reputation for the quality and real value for money.

Therefore you can have complete confidence in placing your trust with Liniar, TruFrame and ourselves, undoubtedly the perfect supply chain.

Advice

You don't get much for Free nowadays, so feel free to accept these tips earned from our 30 Year of experience

- Get at least two quotes, it is good to get a comparison.
- Check them out, social media and trade sites are good for this.
- Get a quote in writing and make sure it states everything you are expecting. We have seen too many cases of 'I didn't get what I expected'
- As replacing windows and doors is covered by Building Regulations, ensure the contractor is a Fensa or Certass member and if not, clarify who is responsible and will pay for a Building Control inspection.
- Do door locks meet with the PAS24 rating that Building Regulations and possibly your insurance company require?.
- Visit a show centre or installation example to see the products before buying. With many products to choose from, you will feel some differences are worth paying more for.

Tel: 0118 956 6866

Email: info@abbeywindows.co.uk

Website: www.abbeywindows.co.uk



ABBHEY

Installing Excellence In The Thames Valley For 30 Years

Address

50a Portman Road
Reading
RG30 1EA